

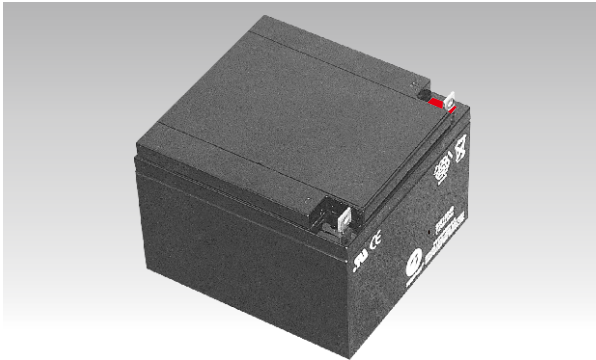

SW12280(12V28AH)

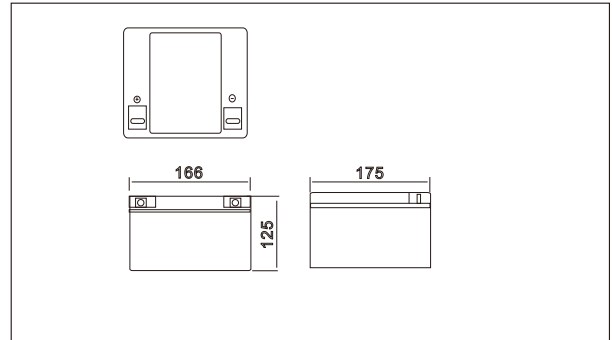

Outer dimensions (mm)



Specifications

Nominal Voltage		12V
Rated capacity (20 hour rate)		28 Ah
Dimensions	Total Height	125 mm (4.92 inches)
	Height	125 mm (4.92 inches)
	Length	175 mm (6.89 inches)
	Width	166 mm (6.54 inches)
Weight Approx		8.0Kg (17.6 lbs)

Terminal Type (mm)

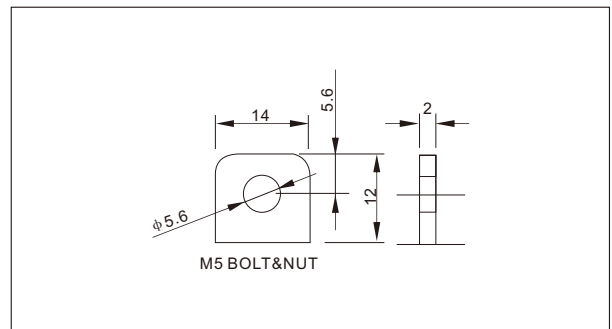

Characteristics

Capacity 25°C(77°F)	20 hour rate(1.40 A)	28.0 AH
	10 hour rate(2.58 A)	25.8AH
	5 hour rate(4.76A)	23.8AH
	1 hour rate(16.80A)	16.8AH
	1.5 hour discharge to 10.5V	11.2 A
Internal Resistance Full charged Battery at 25°C(77°F)		9 mΩ
Capacity affected by Temperature (20hour rate)	40°C(104°F)	102%
	25°C(77°F)	100%
	0°C(32°F)	85%
	-15°C(5°F)	65%
Self-Discharge at 25°C(77°F)	Capacity after 3 month storage	91%
	Capacity after 6 month storage	82%
	Capacity after 12 month storage	64%
Terminal		T4, T13
Charge (constant Voltage)	Cycle	Initial Charging Current less than 11.2 A Voltage 14.20-14.60V
	Float	Voltage 13.50-13.80V

Discharge Curves 25°C(77°F)

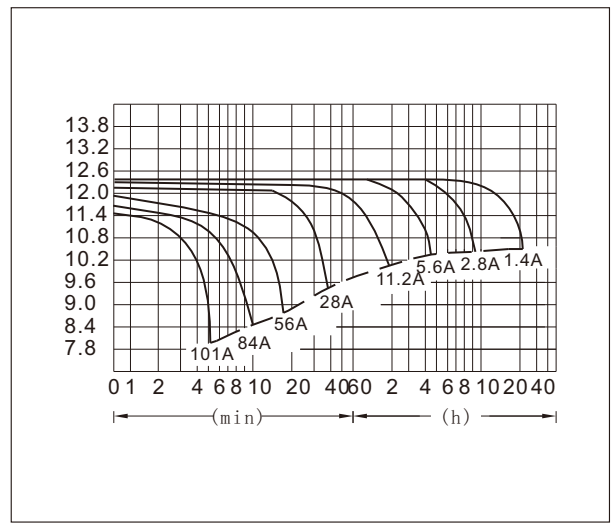

Constant Current(Amp) and Constant Power(Watt) Discharge Table at 25°C(77°F)

Time		5min	10min	15min	30min	1h	2h	3h	4h	5h	8h	10h	20h
9.60V	A	100.80	66.08	49.00	32.20	16.80	9.80	7.21	5.79	4.91	3.24	2.65	1.45
	W	1188.8	746.7	564.7	341.8	193.7	113.4	83.4	67.0	56.8	37.5	30.7	16.8
10.20V	A	92.40	63.23	45.03	30.57	15.77	9.40	7.00	5.60	4.82	3.19	2.60	1.41
	W	1118.8	707.0	530.8	339.5	182.0	108.9	81.1	64.9	55.8	36.9	30.1	16.3
10.50V	A	84.12	59.08	42.00	29.63	15.26	9.22	6.88	5.32	4.80	3.15	2.58	1.40
	W	1080.3	686.0	507.5	336.0	176.6	106.8	79.7	61.6	55.4	36.5	29.9	16.2
10.80V	A	80.84	56.47	39.20	28.82	14.75	8.98	6.77	5.23	4.55	3.07	2.51	1.37
	W	947.3	665.0	488.8	334.8	171.5	104.5	78.8	60.8	53.0	35.0	29.2	15.9
11.10V	A	74.76	53.20	36.40	28.00	14.23	8.75	6.42	5.13	4.35	2.99	2.45	1.33
	W	915.8	642.8	465.5	332.5	169.2	103.8	76.4	60.7	51.8	33.8	28.6	15.8